

BLANCO

Instruction Manual for
60cm Electric Oven

BOSE607M

Dear Customer,

*Thank you for buying a **BLANCO oven**.*

Before we continue telling you about this oven, we cordially invite you to become part of the Blanco family by subscribing online. Please visit our website where you can easily register for product/cooking demonstrations, and request Blanco's gourmet recipes. Go to www.blanco-australia.com and fill in the subscription details in the contact us/showrooms section.

*You will find that the clean lines and modern look of your **Blanco oven** blends in perfectly with your kitchen décor. It is easy to use and performs to a high standard.*

*Blanco also makes a range of products that will enhance your kitchen such as cooktops, rangehoods, dishwashers, microwaves, sinks and taps. There are models to complement your new **Blanco oven**.*

Of course, we make every effort to ensure that our products meet all your requirements, and our Customer Relations department is at your disposal, to answer all your questions and to listen to all your suggestions.

Please complete the warranty card and keep your receipt as proof of purchase. Retain all documents relating to the purchase of this product.

Blanco is committed to providing increasingly efficient products that are easy to use.

Table of Contents

<u>Safety Instructions</u>	4
Warnings	4
Use	4
Maintenance and cleaning	5
<u>Installation of your Oven</u>	6
<u>Electrical Installation</u>	8
<u>Oven Racks</u>	9
<u>Accessories</u>	11
<u>Oven Presentation</u>	12
<u>Cooking Functions</u>	15
<u>Instructions for Use</u>	16
<u>Oven Door Removal</u>	18
<u>Replacement of the Oven Light</u>	19
<u>Guidance Temperature and Time Temperature for Cooking</u>	20
<u>Cooking Recipes</u>	22

Safety Instructions

Important

- When you receive the appliance, unpack it or have it unpacked immediately.

Give it an overall inspection. Make note of any concerns or reservations on the delivery slip and make sure to keep a copy of this form. Keep this user guide with your appliance.

If the appliance is ever sold or transferred to another person, ensure that the new owner receives the user guide. Please become familiar with these recommendations before installing and using your oven. They were written for your safety and the safety of others.

WARNING

- The Appliance is not intended for use by persons (including Children) with reduced physical, sensory or mental capabilities, or lack of experience and knowledge, unless they have been given supervised instruction concerning use of the appliance by a responsible person for their safety.
- Cleaning and maintenance operations must not be carried out by children without supervision.
- Children must be supervised to prevent them from playing with the appliance.

WARNING

- During use the appliance becomes hot. Care should be taken to avoid touching heating elements inside the oven.
- Accessible parts will become hot when in use. To avoid burns and scalds, young children should be kept away.

Use

- Before using your oven for the first time, heat it while empty for approximately 15 minutes.

You should ensure you heat each element in the oven before use. Make sure that the room is sufficiently ventilated. You may notice a particular odour, or a small release of smoke. All of this is normal.

Your appliance is intended for standard household use. Do not use it for commercial or industrial purposes or for any other purpose than that for which it was designed.

This oven was designed for use by private individuals in their homes. It is intended solely for cooking foodstuffs.

This oven does not contain any asbestos-based components.

- Do not modify or attempt to modify any of the characteristics of this appliance. This would be dangerous to your safety.
- Never pull your appliance by the door handle.
- When placing dishes inside or removing them from the oven, do not place your hands close to the upper heating elements and use heat-protective kitchen gloves.
- At the end of cooking, do not pick up oven or grill items (grid) with your bare hands.

- Never place aluminium foil directly in contact with the floor of the oven, as accumulated heat may cause deterioration of the enamel.
- Do not place heavy weights on the open oven door, and make sure that children are able neither to climb nor sit on it.
- Do not use your oven as a larder or to store any items after use.
- After using your oven, make sure that all the controls are in their stop position.
- In addition to the accessories supplied with your oven, only use dishes capable of withstanding high temperatures.

Maintenance and cleaning

- Do not use a steam cleaner.
- For any cleaning operation inside the oven cavity, the oven must be switched off.
- Before unclipping the glass, allow the appliance to cool.
- Before removing the back, ensure that the appliance is powered down. After cleaning, the back should be replaced in accordance.
- Do not use harsh abrasive cleaners or sharp metal scrapers to clean the oven glass door since they can scratch the surface, which may result in shattering of the glass.
- To clean both the electronic programmer window and the oven door, use a soft cloth.
- Do not use cleaning products, abrasive creams, or scouring sponges.

WARNING

- **Make sure the appliance is disconnected from the power before replacing the lamp in order to avoid the risk of electric shock.**
- **Change the lamp only when the appliance has cooled down. To unscrew the view port and the light, use a rubber glove, which will make disassembly easier.**

WARNING

- **Installation should only be performed by qualified installers and technicians.**

WARNING

- **If the electrical supply is restricted, means of all-pole disconnection must be accessible and incorporated in the fixed wiring in accordance with the wiring rules.**
- **If the power cable is damaged, it should be replaced by the manufacturer, its after-sales service department or by a similarly qualified person in order to avoid danger.**

PACKAGING



- This appliance's packing materials are recyclable. Recycle them by depositing them in local authority containers provided for this purpose.



- Your appliance also contains many recyclable materials. It is therefore marked with this logo to indicate that used appliances must not be mixed with other waste.

Installation of your oven

To install the oven into the kitchen a cut out should be made in accordance with the dimensions shown in below. Please allow for 3/ 4mm of a difference in the dimensions provided below. **Please measure the original product to ensure that the cut out details are correct.**

The apparatus is to be fastened to the top by means of the two screws provided in the kit through the holes made on the oven uprights.

The cabinet in which the apparatus is installed shall be open on the back side to ensure a sufficient air circulation and prevent overheating.

Leave a gap of at least 20 cm² for air circulation if the oven is installed in a column; this is not necessary if the oven is installed under the work top.

WARNING

As the apparatus is to be fitted in your kitchen furniture, make sure that all surfaces in contact with the oven can resist a temperature of approx 90°C.

<u>Overall product Dimensions</u>	595 mm	Height
	595 mm	Width
	550 mm	Depth

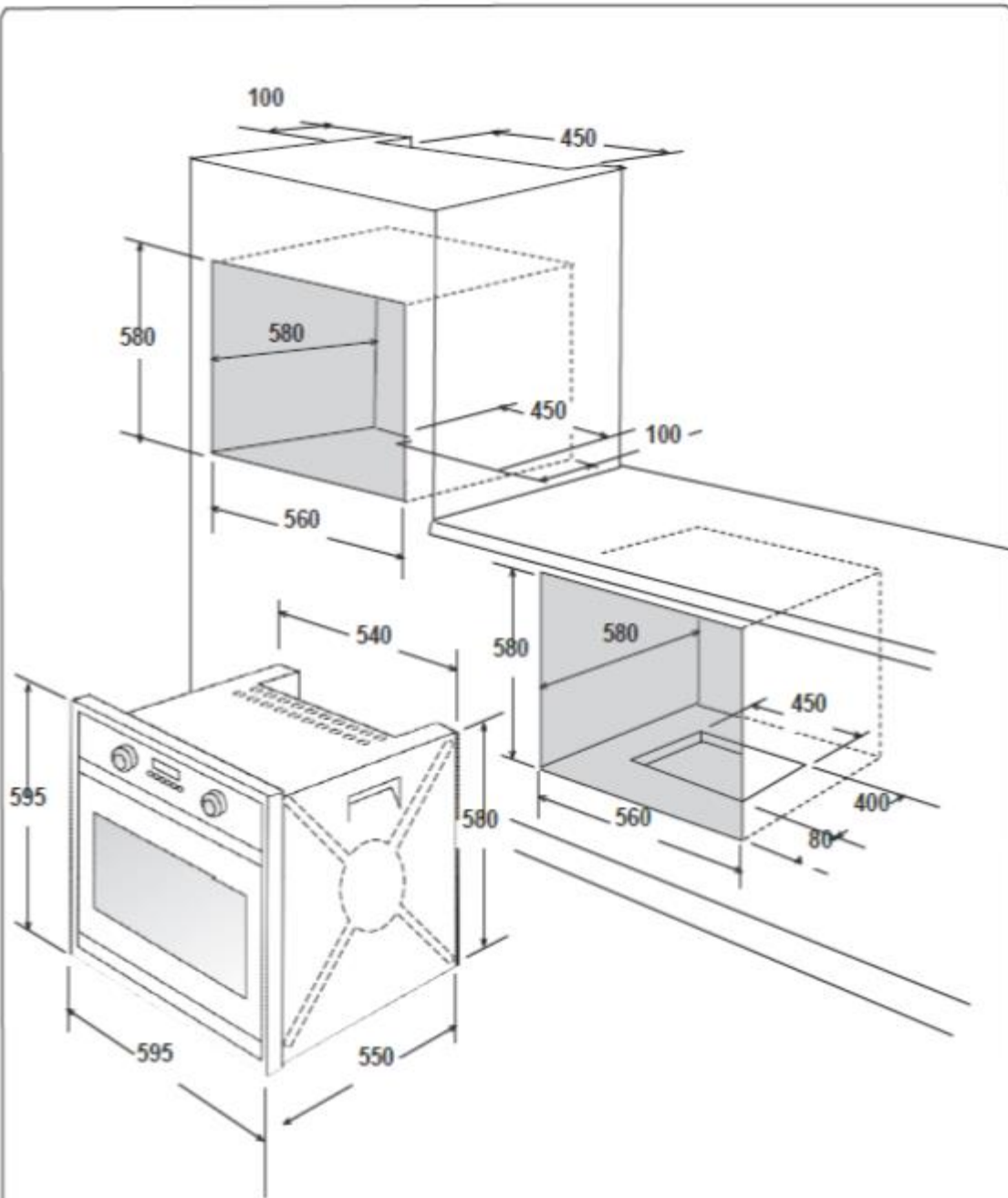

Cabinetry materials must be suitable to withstand temperatures up to 90°C

Dimensions illustrated are for proudmount installation.

Electrical Installation

BOSE607M is a 15 amp appliance which is supplied with a cord. There is no plug supplied. It requires hard wiring by a qualified electrician.

WARNING

This apparatus must be earthed.

The oven is only for domestic use.

The feed voltage and the absorbed power are as indicated on the data plate attached to the left-hand side upright, which can be seen when the oven door is open.

Connecting must be carried out by qualified personnel and in accordance with the regulations currently in force.

The manufacturer cannot be held responsible for any damages to persons or objects caused by failure to observe these instructions.

If the supply cord is damaged, it must be replaced by the manufacturer, its service agent or similarly qualified persons in order to avoid a hazard.

The oven must be connected to the mains through a multiple circuit breaker with a contact-to-contact gap of at least 3 mm, making sure that the earth wire is not disconnected.

For connecting use a flexible cable of the **H05V2V2-F 3x1,5 mm²** type remembering to make it long enough to allow the oven to be removed from its housing unit when maintenance work is required.

To connect the cable to the oven, proceed as follows:

- Remove the lid by unfastening the three screws.
- Unfasten the two screws for the cable holder and feed the cable through the opening immediately below the cover.
- Remove about 12 cm of the outside insulation from the cable and shorten the two active wires (live and neutral) to 6 cm, leaving long the one to be connected to the main earth terminal on the terminal box; remove about 1 cm of the main insulation from the three wires and connect them correctly to the terminal box, Remembering to respect the polarities.
- Tighten the two screws of the cable holder and put the lid back on with the three screws.

Electricals Specification

- Absorbed power:

Grill element:	2200 W
Oven bottom element:	1100 W
Fan forced element:	2300 W
Lamp:	25 W
Hot air fan motor:	20 - 25 W
Cooling fan motor:	25 W

- Maximum absorbed power: (see data plate).

-Supply voltage: (see data plate)

Oven Racks

WARNING

Never use aluminum foil to cover the oven racks or to line the oven. It can cause damage to the oven liner if heat is trapped under the foil.

WARNING

Make sure you do not force it to avoid damage to the enamel.

The oven has rack guides at five levels as per the below image.



Rack positions are numbered from the bottom rack guide (#1) to the top (#5). Check cooking charts for best rack positions to use when cooking. Each level guide consists of paired supports formed in the walls on each side of the oven cavity. Always be sure to position the oven racks before turning on the oven. Make sure that the racks are level once they are in position. The racks are designed to stop when pulled forward to their limit.

Extendable Telescopic Racks

1 of the racks in this oven is an extendable telescopic rack and therefore these racks easily slide out when used, which allows for easy convenience.

The extendable rack allows for easier access to cooking foods. It extends beyond the standard flat rack bringing the food closer to the user.

WARNING

Make sure that:

- **When the rack is outside of the oven, slide arms do not lock. They could unexpectedly extend if the rack is carried incorrectly. Extending slide arms could cause injury. Rack should only be held or carried by grasping the sides.**
- **To avoid burns, pull rack all the way out and lift pan above handle when transferring food to and from oven.**

Accessories

BOSE607M

Accessories which are provided with this oven are as follows:

- 2 x safety anti tip shelves
- 1 x grill pan
- 1 x grill pan insert
- 1 x grill handle
- 1 x extendable telescopic runner
- Catalytic self-cleaning liners – rear and sides

Oven Presentation





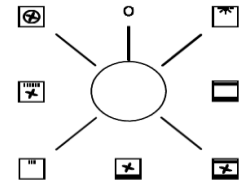
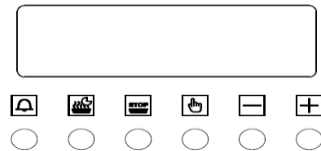
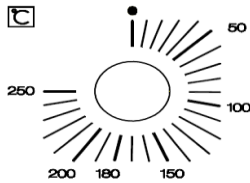

The oven control panel is made up of 2 knobs and one touch control (button) timer display.

- 1 knob for the temperature control
- 1 knob for the oven functions
- Timer display as per the below image.



6 Key Electronic Timer

Please note that the meaning of the 6 keys are as follows:

- 1)  Timer key.
- 2)  Duration key.
- 3)  End of cooking key.
- 4)  Manual operation key which allows you to start cooking without setting the end of cooking time.
- 5)  To set the time or increase the duration of cooking time.
- 6)  To set the time or decrease the duration of cooking time.

Luminous Symbols

When 'AUTO' blinks, this means that the timer is in automatic mode but no setting has yet been made.

When 'AUTO' remains permanently alight, this means that the timer is in automatic mode and already programmed.



Automatic cooking



Timer in operation



Plus 'AUTO' blinking: programming error

If there is no symbol alight other than the digits of the clock, this means that the timer is in manual mode.

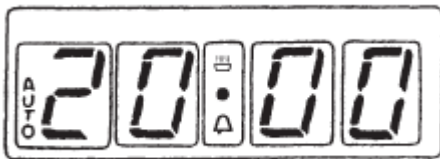

Setting the clock

The timer incorporates a digital electronic clock with luminous numbers indicating the hours and minutes. When the appliance is first connected to the a.c. supply or following a power cut, three zeroes will blink in the timer window. To set the clock press the duration key and the end of cooking key simultaneously, then press the +/- keys to set the time.

Manual Operation

To start cooking without setting end of cooking time, press the manual key.

Fully automatic operation

To set the end of cooking time, press the duration key and press the +/- keys to set the duration of cooking. Press the end of cooking key and press the +/- keys to set the time at which you want the oven to switch off. When you finish setting these times, the 'AUTO' symbol flashes and the buzzer sounds. Press any key to silence it.



Example: We want to cook food for a 30 minute period, ending at 14.00.



- Press and hold duration key, enter 0.30 in the display
- Press and hold end of cooking key, enter 14.00 in the display.
- This done the display will revert to the current time and 'AUTO' reappears, confirming that the settings have been acknowledged and memorized. At 13.30 (14.00 minus 30 minutes) the oven switches on automatically and the symbol 'AUTO' will appear for as long as cooking



continues. The oven will then switch off automatically at 14.00, triggering a beep that can be silenced by pressing the timer key.

Semi-Automatic cooking

- A) Programme the duration
- B) Programme the stop time

A) Select the duration for which the food is to cook by pressing the duration key . The oven will switch on automatically, with the symbols 'AUTO' and  duration key showing on the display. Once the set duration has elapsed, cooking will stop and the beep sounds intermittently. Silence the beep as indicated above.

B) Set the time for cooking to stop, by pressing the  end of cooking key. The oven will switch on immediately, with the 'AUTO' and  showing in the display. When the set time comes around, cooking will stop and the beep sounds intermittently. Silence the beep as indicated above.

Current programming status can be displayed at any given moment by pressing  and resetting the display to zero. Pressing  at this point the programmer will revert to manual mode.

Minute Minder

Press the alarm timer key and press the +/- keys to set the required duration of cooking. The buzzer sounds when the cooking time ends. Press any key to silence it. It is a 60 minute timer.

Programming Errors

You cannot program in a cooking period which starts earlier than the time displayed on the clock. If you try to do so, the buzzer sounds and the 'AUTO' symbol flashes. Simply change the duration or cooking time to correct the error.







Cancelling a cooking programme

To cancel a cooking programme, simply press the manual key.

Cooking Functions

BOSE607M

This oven has 7 specific cooking functions as follows:

<u>Symbol</u>	<u>Description</u>
	Light
	Top and bottom elements/Traditional /Conventional
	Traditional with fan (Fan assist)
	Fan with lower element
	Half grill
	Fan with full grill(Fan Grill)
	Fan forced

Instructions for Use

Top and Bottom Elements Only

A classic system also known as conventional cooking that uses upper and lower heat suitable for cooking a single dish. It is a good idea to insert the food when the oven has reached the pre-set temperature. If you need to increase the temperature towards the end of cooking, use the temperature regulation knob. We recommend opening the door as little as possible during cooking. It is best to use a single layer in the oven preferably keeping the food item in the center of the oven.

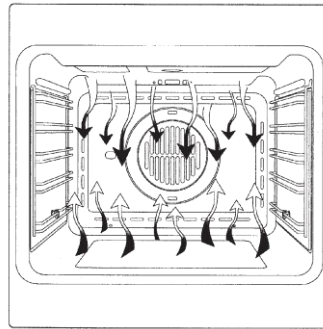

Fan Forced Cooking

For this type of cooking a fan positioned at the back allows the circulation of hot air inside the oven, creating uniform heat. In this way cooking is more rapid than conventional cooking. It is a suitable method for cooking dishes on more than one shelf, especially when the food is of different types (fish, meat etc.).

Grill Cooking

Use this function to grill or brown foods. Some ovens may be equipped with an electric motor, spit and skewers for turning on the spit.

Place the shelf with the food to be cooked in the 1st or 2nd position from the top. Pre-heat the oven for 5 minutes.

Temperature Regulation

Use the thermostat to set the temperature you require. The temperature can be adjusted from 0 to 205°C which is max heat.

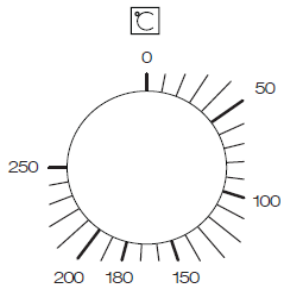

Oven Light Control

In order to achieve the best results in terms of performance and energy consumption, this function is automatically managed by the oven during its functioning. If you want to turn it on at any time, just turn the function knob on the control panel.

Oven Door Removal

WARNING

Make sure that:

- The oven is cool and power to the oven has been turned off before removing the door. Failure to do so could result in electrical shock or burns.
- The oven door is heavy and fragile. Use both hands to remove the oven door. The door front is Glass. Handle care-fully to avoid breakage.
- Grasp only the sides of the oven door. Do not grasp the handle as it may swing in your hand and cause damage or injury.
- Failure to grasp the oven door firmly and properly could result in personal injury or product damage.

To remove the oven door (See Fig. 1):

1. Open the door completely.
2. Lift up the hinge bracket (1) into the slot (2) on both sides.
3. Hold the door firmly on both sides using both hands and close the door as far as it will go.
4. Whilst holding the door with both hands, force the door closed a little more and lift it out of the housing.
5. Place the door in a convenient location.

To replace the oven door (See Fig. 1):

1. Insert the upper arms (3) of both hinges into the upper slots (6) and the lower arms (4) into the lower slots (7). The recesses (5) must hook on the lips (8).
2. Move the hinge brackets (1) back down into position.
3. Close and open the door slowly to assure that it is correctly and securely in place.

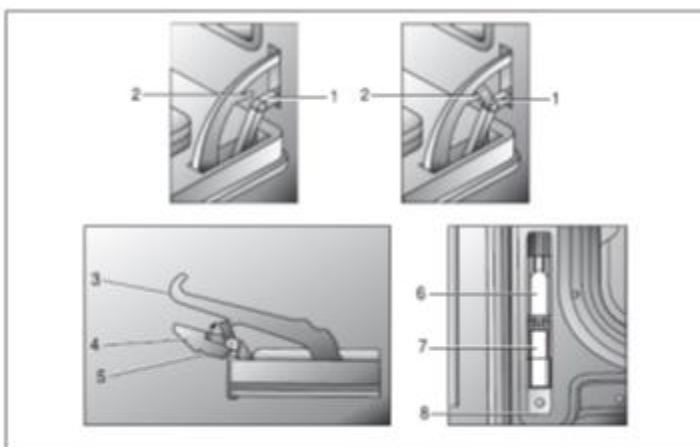

Fig. 1

Replacement of the Oven Light

WARNING

Make sure that:

- The oven and lights are cool and power to the oven has been turned off before replacing the light bulb(s). Failure to do so could result in electrical shock or burns.
- The lenses must be in place when using the oven.
- The lenses serve to protect the light bulb from breaking.
- The lenses are made of glass. Handle carefully to avoid breakage. Broken glass could cause an injury.

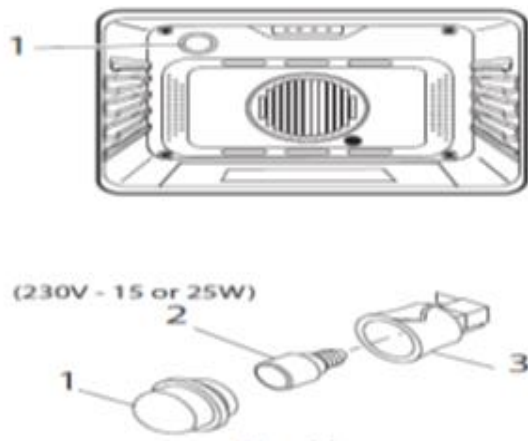



Fig. 2

1. Turn off power at the main power supply (fuse or breaker box).
2. Remove the lens (1) by unscrewing it.
3. Remove the light bulb (2) from its socket (3).
4. Replace the bulb (2) with a new one. Avoid touching the bulb with fingers, as oils from hands can damage the bulb when it becomes hot.
5. Use one with the same Volt and Watt (See Fig. 2).
6. Screw the lens (1) back on.
7. Turn power back on at the main power supply (fuse or breaker box).

Guidance Temperature and Time Temperature for Cooking

Every function has a set temperature chosen on the basis of cooking tests using frequently used recipes and can easily be adjusted to suit personal preference.

The following table contains the results of the cooking tests carried out in our laboratories by a professional chef. However, this is merely a guide and the values indicated are simply to help you get started.

Dish	Temperature in degrees centigrade	Approximate cooking time in minutes
	 	
Sweets	175 160	55-65
Short pastry flan base	200 190	8-10
Fruit pie/tart	200 190	25-35
White leavened bread per 1 kg flour	200 190	30-50
Shortcake biscuits	200 190	10-15
Savoury biscuits	200 190	15-20
Lasagne	225 210	40-50
Meat (cooking time based on thickness)		
Slow roast	175 170	12-15
Quick roast	200 190	12-15
Meat loaf	200 190	30-40
Poultry		
Duck 1.5 -2 kg	200 170	120-180
Goose 3 kg	200 180	150-210
Roast chicken	200 190	60-90
Turkey 5 kg	175 150	240 ca.
Game		
Hare	200 180	60-90
Leg of roebuck	200 180	90-150
Haunch of venison	175 175	90-180
Vegetable		
Vegetable soufflé	200 180	40-45
Fish	180 170	40-45
Pizza	210 200	20-25
Grills		
Pork chop		8-12
Sausage		10-12
Grilled chicken		25-35

COOKING TABLE FOR TOP OVEN - CONVENTIONAL COOKING

IN HEATING SYSTEM WITH TOP AND BOTTOM HEATERS OPERATING. It is recommended to preheat the oven 10 min.

DISHES	LEVEL	TEMPERATURE	COOKING TIME
Yorkshire Puddin	1	225°C	30 - 40 min
Fatless Sponge Cake	1	180°C	25 - 30 min
Small Cakes	2	190°C	15 - 20 min
Fruit Plate Tart	1	200°C	40 - 45 min
Scones	2	220°C	10 - 15 min
Rich Fruit Cake	1	140°C	2 - 3 hours

Grilling is carried out at the door closed. 5 minutes oven preheating is recommended. Setting possibility from 50 - max (250)°C. Food is placed on the backing pan grid.

DISHES	LEVEL	TEMPERATURE	COOKING TIME	
			Side 1	Side 2
Pork steaks, Chops (4 pcs)	3	250°C	12 min	10 min
Grilled Sausages (6 pcs)	3	250°C	6 min	5 min
Toast (6 pcs)	3	250°C	1 min/25 sec.	1 min/10 sec.

Cooking Recipes

Beef Wellington

Preheat oven to 180-190°C on Fan Assist or 200°C on Fan Forced

Ingredients:

2 tablespoons extra virgin olive oil
4 pieces of beef fillet (150g each)
2 tablespoons brandy
150g mushrooms, finely chopped
2 tablespoons chopped spring onion
4 sheets puff pastry
4 tablespoons fresh breadcrumbs
50g chicken liver pate- Optional
1 egg yolk, beaten, to brush

Method:

- Heat olive oil in frying pan over high heat, add beef fillet and sear quickly on both sides, pour brandy over beef and quickly light for flaming effect.
- Once extinguished transfer beef to plate lined with paper towel and set aside to cool.
- Heat remaining oil in pan and add mushrooms and spring onions. Cook over medium heat for 1-2 minutes.
- Lay out pastry sheets and sprinkle some breadcrumbs in the centre of each. Place the beef on top of pastry; the breadcrumbs absorb any excess juice. Top the beef with a slice of pate and some mushroom mixture.
- Fold up the pastry to enclose, and trim any excess. Press pastry edges together and garnish with any pastry trimmings.
- Brush with egg yolk and transfer to lightly greased oven tray.
- Bake in the oven for about 18 minutes or until the pastry is golden.

Berry and Ricotta Tart

Preheat oven 170-180 °C on Bottom Element and Fan.

Ingredients:

Pastry

125g butter, chilled and cubed

1 egg lightly beaten

1/3 cup icing sugar

½ cup group almonds

1 ½ cup plain flour

Filling

200g fresh ricotta

½ cup cream

2 eggs

2/3 cup castor sugar

½ cup raspberries

½ cup blueberries

1 teaspoon vanilla extract

Method:

- Grease a 26cm tart tin
- Place flour, icing sugar, almonds and butter into a food processor and process until mixture just comes together. Alternately rub the butter into the dry ingredients until it resembles fine breadcrumbs, add egg and stir until the mixture comes together.
- Turn onto a floured surface and gather into a ball. Wrap in plastic wrap and refrigerate for 30 minutes.
- Roll out the pastry between two pieces of baking paper. Roll out to fit the base and sides of the tin. Trim away any excess pastry and refrigerate pastry case for 30 minutes.
- Mix ricotta, vanilla, egg, sugar and cream in a food processor until smooth.
- Fill chilled pastry case with ricotta mixture and sprinkle berries gently over filling.
- Place in preheated oven for 30-35 minutes.
- Cool and dust with icing sugar to serve.

NOTE: Pastry will make enough for two cases. Either bake both cases and leave in an airtight container for up to a week, or freeze half the uncooked dough for up to two months.

Mediterranean Pizza

Preheat oven to 180' C on Fan Forced.

Method: Bake for 15-20 min

Ingredients:

1 uncooked Pizza Base	Marinated artichokes
2 tablespoons of pasta sauce	Kalamata olives
Chargrilled eggplant	Sundried tomatoes
Chargrilled capsicum	Zucchini diced
1 cup pizza cheese	Mushrooms sliced
2 tablespoons parmesan cheese	Onion diced
2 tablespoons fresh rosemary	Roma tomato diced

Method:

- Start with placing the sauce on base pizza and then add the cheese.
- Layer vegetables on the pizza base.
- Sprinkle cheese and herbs on top of the vegetables.
- Cook for approximately 15-20 minutes or until base is crisp and cheese has melted.
- Serve with fries or salad.

Spinach, Ricotta and Goats Cheese Muffins

Preheat oven to 170°C on Fan Forced.

Ingredients:

30g butter
1 cup milk
70g baby spinach
1 ½ cups plain flour
1 tablespoon baking powder
1 tablespoon chopped rosemary
1 tablespoon chopped chives
1 garlic clove crushed
2 tablespoons parmesan cheese (finely grated)
150g goats cheese fetta
1 egg, lightly whisked
¼ cup olive oil
8 Cherry tomatoes
Salt and Pepper to taste

Method:

- Line a muffin tray with 8 muffin paper cup holders and lightly spray with cooking oil
- In a large bowl sift flour, bicarb-soda and baking powder together and set aside
- In a medium size fry pan, melt butter and add baby spinach, garlic, fresh herbs, salt and pepper and milk.
- Cook on a medium heat until baby spinach has wilted and set aside to cool, once cooled, blend spinach mixture until spinach leaves are finely chopped
- Mix ricotta, goats cheese and parmesan until combined.
- Add all cheeses, whisked egg, olive oil and spinach mixture to flour and stir until combined
- Fill muffin cups to ¾ full, slightly push a cherry tomato in the centre and place in oven for approximately 16 minutes
- Serve warm

We appreciate your feedback.

Please review our products on [www. blanco-australia.com](http://www.blanco-australia.com)