

BLANCO

Instruction Manual for
Electric Ovens

BOSE65XM

Dear Customer,

*Thank you for buying a **BLANCO** oven.*

Before we continue telling you about this oven, we cordially invite you to become part of the Blanco family by subscribing online. Please visit our website where you can easily register for product/cooking demonstrations, and request Blanco's gourmet recipes. Go to www.blanco-australia.com and fill in the subscription details in the contact us/showrooms section.

*You will find that the clean lines and modern look of your **Blanco oven** blends in perfectly with your kitchen décor. It is easy to use and performs to a high standard.*

*Blanco also makes a range of products that will enhance your kitchen such as cooktops, rangehoods, dishwashers, microwaves, sinks and taps. There are models to complement your new **Blanco oven**.*

Of course, we make every effort to ensure that our products meet all your requirements, and our Customer Relations department is at your disposal, to answer all your questions and to listen to all your suggestions.

Please complete the warranty card and keep your receipt as proof of purchase. Retain all documents relating to the purchase of this product.

Blanco is committed to providing increasingly efficient products that are easy to use.

Table of Contents

<u>Safety Instructions</u>	4
Warnings	4
Use	4
Maintenance and cleaning	5
<u>Installation of your Oven</u>	6
<u>Electrical Installation</u>	8
<u>Oven Racks</u>	9
<u>Accessories</u>	10
<u>Oven Presentation</u>	11
<u>Cooking Functions</u>	15
<u>Instructions for Use</u>	16
<u>Oven Door Removal</u>	18
<u>Replacement of the Oven Light</u>	20
<u>Guidance Temperature and Time Temperature for Cooking</u>	21
<u>Cooking Recipes</u>	23

Safety Instructions

Important

- **When you receive the appliance, unpack it or have it unpacked immediately.**

Give it an overall inspection. Make note of any concerns or reservations on the delivery slip and make sure to keep a copy of this form. Keep this user guide with your appliance.

If the appliance is ever sold or transferred to another person, ensure that the new owner receives the user guide. Please become familiar with these recommendations before installing and using your oven. They were written for your safety and the safety of others.

WARNING

- **The Appliance is not intended for use by persons (including Children) with reduced physical, sensory or mental capabilities, or lack of experience and knowledge, unless they have been given supervised instruction concerning use of the appliance by a responsible person for their safety.**
- **Cleaning and maintenance operations must not be carried out by children without supervision.**
- **Children must be supervised to prevent them from playing with the appliance.**

WARNING

- **During use the appliance becomes hot. Care should be taken to avoid touching heating elements inside the oven.**
- **Accessible parts will become hot when in use. To avoid burns and scalds, young children should be kept away.**

Use

- Before using your oven for the first time, heat it while empty for approximately 15 minutes.

You should ensure you heat each element in the oven before use. Make sure that the room is sufficiently ventilated. You may notice a particular odour, or a small release of smoke. All of this is normal.

Your appliance is intended for standard household use. Do not use it for commercial or industrial purposes or for any other purpose than that for which it was designed.

This oven was designed for use by private individuals in their homes. It is intended solely for cooking foodstuffs.

This oven does not contain any asbestos-based components.

- Do not modify or attempt to modify any of the characteristics of this appliance. This would be dangerous to your safety.
- Never pull your appliance by the door handle.
- When placing dishes inside or removing them from the oven, do not place your hands close to the upper heating elements and use heat-protective kitchen gloves.
- At the end of cooking, do not pick up oven or grill items (grid) with your bare hands.
- Never place aluminium foil directly in contact with the floor of the oven, as accumulated heat may cause deterioration of the enamel.
- Do not place heavy weights on the open oven door, and make sure that children are able neither to climb nor sit on it.
- Do not use your oven as a larder or to store any items after use.
- After using your oven, make sure that all the controls are in their stop position.
- In addition to the accessories supplied with your oven, only use dishes capable of withstanding high temperatures.

Maintenance and cleaning

- Do not use a steam cleaner.
- For any cleaning operation inside the oven cavity, the oven must be switched off.
- Before unclipping the door, allow the appliance to cool.
- Before removing the back, ensure that the appliance is powered down. After cleaning, the back should be replaced.
- Do not use harsh abrasive cleaners or sharp metal scrapers to clean the oven glass door since they can scratch the surface, which may result in shattering of the glass.
- To clean both the electronic programmer window and the oven door, use a soft cloth.
- Do not use cleaning products, abrasive creams, or scouring sponges.

WARNING

- **Make sure the appliance is disconnected from the power before replacing the lamp in order to avoid the risk of electric shock.**
- **Change the lamp only when the appliance has cooled down. To unscrew the view port and the light, use a rubber glove, which will make disassembly easier.**

WARNING

- **Installation should only be performed by qualified installers and technicians.**

WARNING

- **If the electrical supply is restricted, means of all-pole disconnection must be accessible and incorporated in the fixed wiring in accordance with the wiring rules.**
- **If the power cable is damaged, it should be replaced by the manufacturer, its after-sales service department or by a similarly qualified person in order to avoid danger.**

PACKAGING



- This appliance's packing materials are recyclable. Recycle them by depositing them in local authority containers provided for this purpose.
- Your appliance also contains many recyclable materials. It is therefore marked with this logo to indicate that used appliances must not be mixed with other waste.

Installation of your oven

To install the oven into the kitchen a cut out should be made in accordance with the dimensions shown in below. Please allow for 3/ 4mm of a difference in the dimensions provided below. **Please measure the original product to ensure that the cut out details are correct.**

The apparatus is to be fastened to the top by means of the two screws provided in the kit through the holes made on the oven uprights.

The cabinet in which the apparatus is installed shall be open on the back side to ensure a sufficient air circulation and prevent overheating.

Leave a gap of at least 20 cm² for air circulation if the oven is installed in a column; this is not necessary if the oven is installed under the work top.

WARNING

As the apparatus is to be fitted in your kitchen furniture, make sure that all surfaces in contact with the oven can resist a temperature of approx 90°C.

<u>Overall product Dimensions</u>	595 mm	Height
	595 mm	Width
	550 mm	Depth

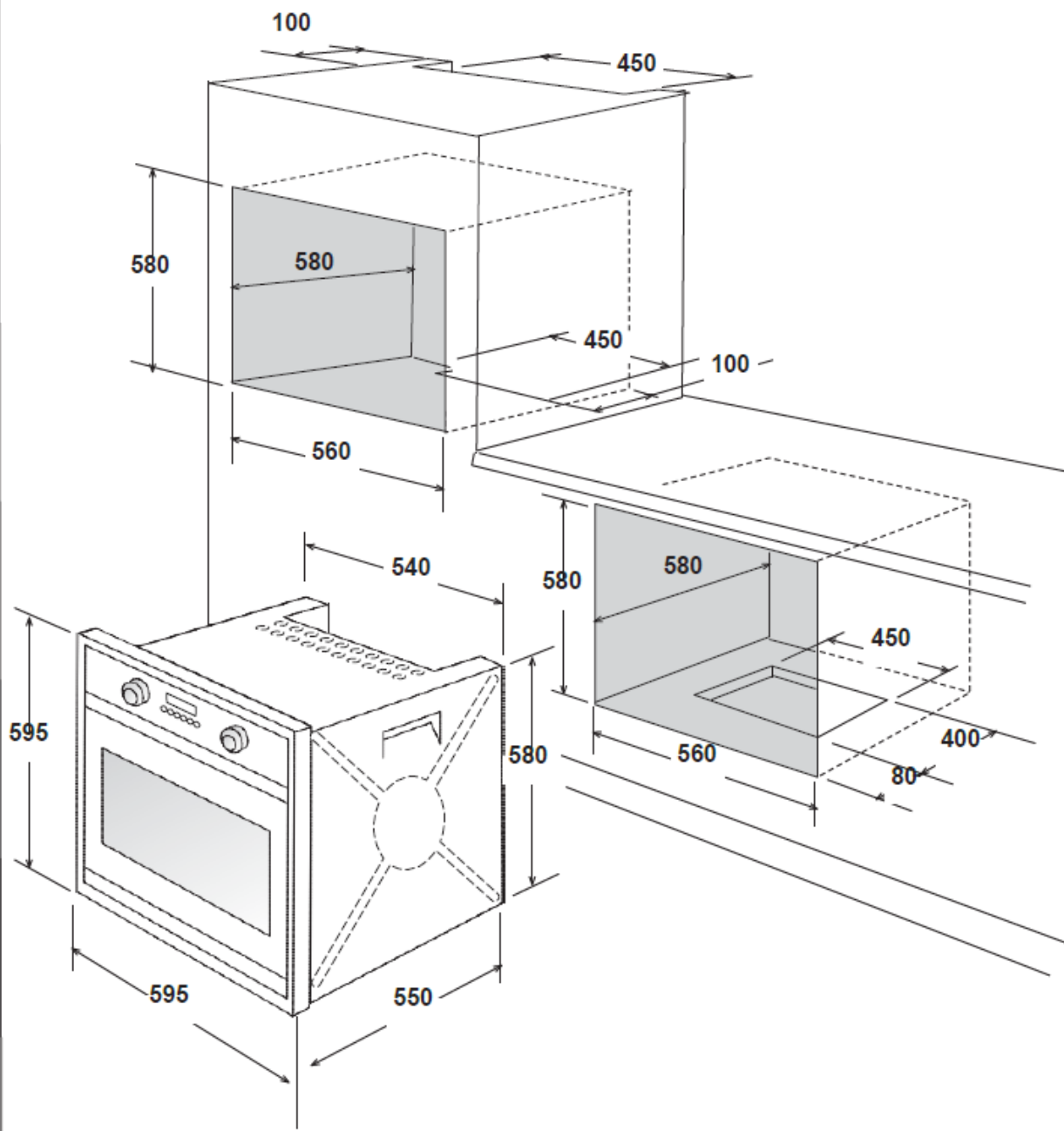

Cabinetry materials must be suitable to withstand temperatures up to 90°C

Dimensions illustrated are for proudmount installation.

Electrical Installation

BOSE65XM is a 10 amp appliance.

WARNING This apparatus must be earthed.

The oven is only for domestic use.

The feed voltage and the absorbed power are as indicated on the data plate attached to the left-hand side upright, which can be seen when the oven door is open.

Connecting must be carried out by qualified personnel and in accordance with the regulations currently in force.

The manufacturer cannot be held responsible for any damages to persons or objects caused by failure to observe these instructions.

If the supply cord is damaged, it must be replaced by the manufacturer, its service agent or similarly qualified persons in order to avoid a hazard.

The oven must be connected to the mains through a multiple circuit breaker with a contact-to-contact gap of at least 3 mm, making sure that the earth wire is not disconnected.

For connecting use a flexible cable of the **H05V2V2-F 3x1,5 mm²** type remembering to make it long enough to allow the oven to be removed from its housing unit when maintenance work is required.

To connect the cable to the oven, proceed as follows:

- Remove the lid by unfastening the three screws.
- Unfasten the two screws for the cable holder and feed the cable through the opening immediately below the cover.
- Remove about 12 cm of the outside insulation from the cable and shorten the two active wires (live and neutral) to 6 cm, leaving long the one to be connected to the main earth terminal on the terminal box; remove about 1 cm of the main insulation from the three wires and connect them correctly to the terminal box, Remembering to respect the polarities.
- Tighten the two screws of the cable holder and put the lid back on with the three screws.

Electricals Specification

BOSE65XM

- Absorbed power:

Grill element:	2200W
Fan forced element:	2300 W
Lamp:	25 W
Hot air fan motor:	20 - 25 W
Cooling fan motor:	25 W

- **Maximum absorbed power:** (see data plate).

- **Supply voltage:** (see data plate)

Oven Racks

WARNING

Never use aluminum foil to cover the oven racks or to line the oven. It can cause damage to the oven liner if heat is trapped under the foil.

WARNING

Make sure you do not force it to avoid damage to the enamel.

The oven has rack guides at five levels as per the below image.



Rack positions are numbered from the bottom rack guide (#1) to the top (#5). Check cooking charts for best rack positions to use when cooking. Each level guide consists of paired supports formed in the walls on each side of the oven cavity. Always be sure to position the oven racks before turning on the oven. Make sure that the racks are level once they are in position. The racks are designed to stop when pulled forward to their limit.

Accessories

BOSE65XM

Included accessories which are provided with this oven are as follows:

- 2 x safety anti tip shelves
- 1 x grill pan
- 1 x grill pan insert
- 1 x grill handle

Oven Presentation

The oven control panel is made up of 2 knobs and one touch control timer display.

- 1 knob for the temperature control
- 1 knob for the oven functions
- Touch control timer display as per the below image. (Please note that the display colour in the oven is red when lit and not white as shown in these images)

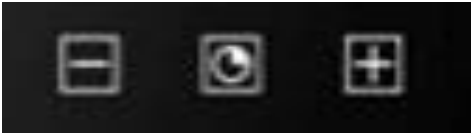

TIMER TOUCH CONTROL

Setting the clock



Fig.1

“Auto” and “0:00” will start flashing when the unit is switched on for the first time. To set the clock, press the central button for about 3 seconds. When  appears, press “+” or “-” to set the correct time.

Wait until a beep tells you that the clock has been set (fig. 1).

To set the time at a later stage, press “+” and “-” together for 3 seconds and then adjust the clock as described above.

Minute counter



Fig. 2

As this minute counter does not control the oven, when it finishes counting the oven will continue to work.

To set, press the central button for 3 seconds until the below symbol appears (fig. 2). Press “+” and “-” to set the required time.



The minute counter beeps when it finishes counting. To disable it, press any button. To cancel the minute counter press the ‘-’ button until the timer displays 0:00

Cooking time



Fig. 3

This is a semi-automatic cooking function. It can be used to set cooking times. This function automatically switches the oven off after the duration is complete. Firstly your cooking mode and temperature should be set.

Press the central button for 3 seconds. Then press it again until “dur” appears (figure 3). Press “+” and “-” to set the required cooking timer.

The oven will work in the set mode and at the set temperature until the end of cooking time. To cancel the cooking duration press the ‘-’ button until the timer displays 0:00.

The end of cooking time



Fig. 4

The end of cooking time can also be set. This works as part of a programmed time. Press the central button for 3 seconds. Press the central button twice consecutively and wait for "End" to appear. Press "+" and "-" to set the required end of cooking time. The oven will work in the set mode and at the set temperature until the end of cooking time.

Setting Programming automatic cooking



Fig. 5

Cooking function with set times.

Firstly your cooking mode and temperature should be set. Press the central button for 3 seconds. Then press it again until "dur" appears. Press "+" and "-" to set the required cooking time. Wait 2 seconds for the setting to be memorised. Press the central button again, "End" will appear (fig. 4). Press "+" and "-" to set the required end of cooking time. The oven will switch off and the word AUTO will appear in the display.

E.g.:

Current time: 12.30

Cooking time: 10 minutes

End of cooking time: 14.00

The oven will start cooking at 13.50 (14.00 less 00.10) at the set temperature and in the set mode and will stop at 14.00

The oven will beep when it stops cooking. To disable it, press any button.

Adjusting beep volume







To adjust beep volume, press “+” and “-” together. Then press the central button and wait for “ton1” (high volume) to flash. Press “-” to select “ton2” (medium volume) or “ton3” (low volume). Press the central button to set the selected volume.

Cooking Functions

BOSE65XM

This oven has 5 specific cooking functions as follows:

<u>Symbol</u>	<u>Description</u>
	Light
	Defrost
	Fan forced
	Full grill
	Fan grill

Instructions for Use

Fan forced cooking

For this type of cooking a fan positioned at the back allows the circulation of hot air inside the oven, creating uniform heat. In this way cooking is more rapid than conventional cooking. It is a suitable method for cooking dishes on more than one shelf, especially when the food is of different types (fish, meat etc.).

Grill Cooking

Use this function to grill or brown foods. Some ovens may be equipped with an electric motor, spit and skewers for turning on the spit. Place the shelf with the food to be cooked in the 1st or 2nd position from the top. Pre-heat the oven for 5 minutes.

Temperature Regulation

Use the thermostat to set the temperature you require. The temperature can be adjusted from 0 to 205°C which is max heat.

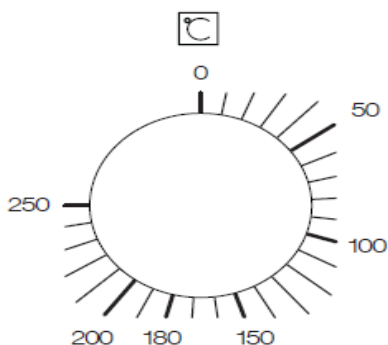

Oven Light Control

In order to achieve the best results in terms of performance and energy consumption, this function is automatically managed by the oven during its functioning. If you want to turn it on at any time, just turn the function knob on the control panel.

Oven Door Removal

WARNING

Make sure that:

- **The oven is cool and power to the oven has been turned off before removing the door. Failure to do so could result in electrical shock or burns.**
- **The oven door is heavy and fragile. Use both hands to remove the oven door. The door front is Glass. Handle carefully to avoid breakage.**
- **Grasp only the sides of the oven door. Do not grasp the handle as it may swing in your hand and cause damage or injury.**
- **Failure to grasp the oven door firmly and properly could result in personal injury or product damage.**

To remove the oven door (see Fig. 10):

1. Open the door completely.
2. Lift up the hinge bracket (1) into the slot (2) on both sides.
3. Hold the door firmly on both sides using both hands and close the door as far as it will go.
4. Whilst holding the door with both hands, force the door closed a little more and lift it out of the housing.
5. Place the door in a convenient location.

To replace the oven door (see Fig. 10):

1. Insert the upper arms (3) of both hinges into the upper slots (6) and the lower arms (4) into the lower slots (7). The recesses (5) must hook on the lips (8).
2. Move the hinge brackets (1) back down into position.
3. Close and open the door slowly to assure that it is correctly and securely in place.

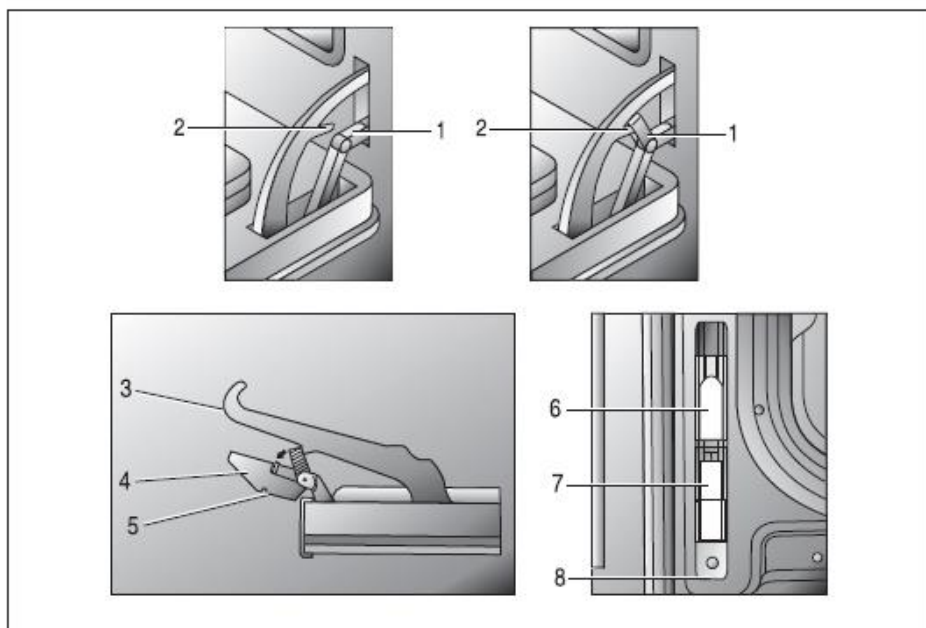

Fig. 10

Replacement of the Oven Light

WARNING

Make sure that:

- The oven and lights are cool and power to the oven has been turned off before replacing the light bulb(s). Failure to do so could result in electrical shock or burns.
- The lenses must be in place when using the oven.
- The lenses serve to protect the light bulb from breaking.
- The lenses are made of glass. Handle carefully to avoid breakage. Broken glass could cause an injury.

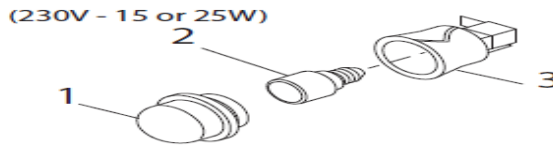
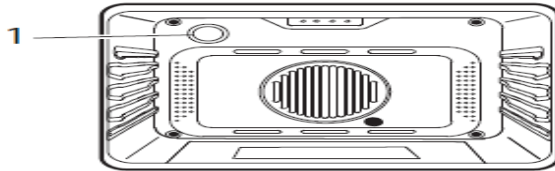



Fig. 11

1. Turn off power at the main power supply (fuse or breaker box).
2. Remove the lens (1) by unscrewing it.
3. Remove the light bulb (2) from its socket (3).
4. Replace the bulb (2) with a new one. Avoid touching the bulb with fingers, as oils from hands can damage the bulb when it becomes hot.
5. Use one with the same Volt and Watt (see Fig. 11).
6. Screw the lens (1) back on.
7. Turn power back on at the main power supply (fuse or breaker box).

Guidance Temperature and Time Temperature for Cooking

Every function has a set temperature chosen on the basis of cooking tests using frequently used recipes and can easily be adjusted to suit personal preference.

The following tables contain the results of the cooking tests carried out in our laboratories by a professional chef. However, this is merely a guide and the values indicated are simply to help you get started.

Dish	Temperature in degrees centigrade	Approximate cooking time in minutes
	 	
Sweets	175 160	55-65
Short pastry flan base	200 190	8-10
Fruit pie/tart	200 190	25-35
White leavened bread per 1 kg flour	200 190	30-50
Shortcake biscuits	200 190	10-15
Savoury biscuits	200 190	15-20
Lasagne	225 210	40-50
Meat (cooking time based on thickness)		
Slow roast	175 170	12-15
Quick roast	200 190	12-15
Meat loaf	200 190	30-40
Poultry		
Duck 1.5 -2 kg	200 170	120-180
Goose 3 kg	200 180	150-210
Roast chicken	200 190	60-90
Turkey 5 kg	175 150	240 ca.
Game		
Hare	200 180	60-90
Leg of roebuck	200 180	90-150
Haunch of venison	175 175	90-180
Vegetable		
Vegetable soufflé	200 180	40-45
Fish	180 170	40-45
Pizza	210 200	20-25
Grills		
Pork chop		8-12
Sausage		10-12
Grilled chicken		25-35

COOKING TABLE FOR TOP OVEN - CONVENTIONAL COOKING

IN HEATING SYSTEM WITH TOP AND BOTTOM HEATERS OPERATING. It is recommended to preheat the oven 10 min.

DISHES	LEVEL	TEMPERATURE	COOKING TIME
Yorkshire Puddin	1	225°C	30 - 40 min
Fatless Sponge Cake	1	180°C	25 - 30 min
Small Cakes	2	190°C	15 - 20 min
Fruit Plate Tart	1	200°C	40 - 45 min
Scones	2	220°C	10 - 15 min
Rich Fruit Cake	1	140°C	2 - 3 hours

Grilling is carried out at the door closed. 5 minutes oven preheating is recommended. Setting possibility from 50 - max (250)°C. Food is placed on the backing pan grid.

DISHES	LEVEL	TEMPERATURE	COOKING TIME	
			Side 1	Side 2
Pork steaks, Chops (4 pcs)	3	250°C	12 min	10 min
Grilled Sausages (6 pcs)	3	250°C	6 min	5 min
Toast (6 pcs)	3	250°C	1 min/25 sec.	1 min/10 sec.

Cooking Recipes

Beef Wellington

Preheat oven to 180-190°C on Fan Assist or 200°C on Fan Forced

Ingredients:

2 tablespoons extra virgin olive oil
4 pieces of beef fillet (150g each)
2 tablespoons brandy
150g mushrooms, finely chopped
2 tablespoons chopped spring onion
4 sheets puff pastry
4 tablespoons fresh breadcrumbs
50g chicken liver pate- Optional
1 egg yolk, beaten, to brush

Method:

- Heat olive oil in frying pan over high heat, add beef fillet and sear quickly on both sides, pour brandy over beef and quickly light for flaming effect.
- Once extinguished transfer beef to plate lined with paper towel and set aside to cool.
- Heat remaining oil in pan and add mushrooms and spring onions. Cook over medium heat for 1-2 minutes.
- Lay out pastry sheets and sprinkle some breadcrumbs in the centre of each. Place the beef on top of pastry; the breadcrumbs absorb any excess juice. Top the beef with a slice of pate and some mushroom mixture.

- Fold up the pastry to enclose, and trim any excess. Press pastry edges together and garnish with any pastry trimmings.
- Brush with egg yolk and transfer to lightly greased oven tray.
- Bake in the oven for about 18 minutes or until the pastry is golden.

Berry and Ricotta Tart

Preheat oven 170-180 °C on Bottom Element and Fan.

Ingredients:

Pastry

125g butter, chilled and cubed
1 egg lightly beaten
1/3 cup icing sugar
½ cup group almonds
1 ½ cup plain flour

Filling

200g fresh ricotta
½ cup cream
2 eggs
2/3 cup castor sugar
½ cup raspberries
½ cup blueberries

1 teaspoon vanilla extract

Method:

- Grease a 26cm tart tin
- Place flour, icing sugar, almonds and butter into a food processor and process until mixture just comes together. Alternately rub the butter into the dry ingredients until it resembles fine breadcrumbs, add egg and stir until the mixture comes together.
- Turn onto a floured surface and gather into a ball. Wrap in plastic wrap and refrigerate for 30 minutes.
- Roll out the pastry between two pieces of baking paper. Roll out to fit the base and sides of the tin. Trim away any excess pastry and refrigerate pastry case for 30 minutes.
- Mix ricotta, vanilla, egg, sugar and cream in a food processor until smooth.
- Fill chilled pastry case with ricotta mixture and sprinkle berries gently over filling.
- Place in preheated oven for 30-35 minutes
- Cool and dust with icing sugar to serve.

NOTE: Pastry will make enough for two cases. Either bake both cases and leave in an airtight container for up to a week, or freeze half the uncooked dough for up to two months.

Mediterranean Pizza

Preheat oven to 180' C on Fan Forced.

Method: Bake for 15-20 min

Ingredients:

1 uncooked Pizza Base	Marinated artichokes
2 tablespoons of pasta sauce	Kalamata olives
Chargrilled eggplant	Sundried tomatoes
Chargrilled capsicum	Zucchini diced
1 cup pizza cheese	Mushrooms sliced
2 tablespoons parmesan cheese	Onion diced
2 tablespoons fresh rosemary	Roma tomato diced

Method:

- Start with placing the sauce on base pizza and then add the cheese.
- Layer vegetables on the pizza base.
- Sprinkle cheese and herbs on top of the vegetables.
- Cook for approximately 15-20 minutes or until base is crisp and cheese has melted.
- Serve with fries or salad.

Spinach, Ricotta and Goats Cheese Muffins

Pre heat oven to 170°C on fan forced.

Ingredients:

30g butter
1 cup milk
70g baby spinach
1 ½ cups plain flour
1 tablespoon baking powder
1 tablespoon chopped rosemary
1 tablespoon chopped chives
1 garlic clove crushed
2 tablespoons parmesan cheese (finely grated)
150g goats cheese fetta
1 egg, lightly whisked
¼ cup olive oil
8 Cherry tomatoes
Salt and Pepper to taste

Method:

- Line a muffin tray with 8 muffin paper cup holders and lightly spray with cooking oil
- In a large bowl sift flour , bicarb-soda and baking powder together and set aside
- In a medium size fry pan, melt butter and add baby spinach, garlic, fresh herbs, salt and pepper and milk.
- Cook on a medium heat until baby spinach has wilted and set aside to cool, once cooled, blend spinach mixture until spinach leaves are finely chopped
- Mix ricotta, goats cheese and parmesan until combined.
- Add all cheeses, whisked egg, olive oil and spinach mixture to flour and stir until combined
- Fill muffin cups to ¾ full, slightly push a cherry tomato in the centre and place in oven for approximately 16 minutes
- Serve warm

We appreciate your feedback.
**Please review our products on [www. blanco-
australia.co](http://www.blanco-australia.co)**

